

EAT•N

Powerware

Powerware® 9395 UPS

Product Focus

225-550 kVA



Powerware 9395

Introduction and overview

With an unprecedented level of power performance, reliability, and energy savings, the state-of-the-art Powerware 9395 UPS has raised the bar in three-phase power protection technology. As IT managers, facility managers and CIOs feel increasing pressure to achieve zero downtime, and availability requirements rise, the search for the most reliable and efficient power protection system has become even more critical. But that search is now over. For more than 40 years, Eaton® has been dedicated to delivering the most technologically advanced products for our customers' mission-critical applications—a commitment exemplified by the new Powerware 9395. More than an innovative, cutting-edge UPS, it's a quantum leap in three-phase technology.

The Powerware 9395 delivers a wide scope of superior customer-driven benefits unmatched by competitive UPS solutions, including:

- **Best total reliability:** Isolates critical loads from power disturbances with the highest level of protection possible using proven double-conversion technology and a truly redundant design
- **Unmatched green power performance:** Provides the highest electrical and cooling savings through unrivaled power performance for efficiency, input current harmonic distortion (THD), and power factor
- **Scalable, redundant architecture meets current and future load requirements:** Grows with changing power requirements using scalable architecture that allows users to add another 275 kVA module on-site later for capacity or redundancy
- **Integrates into total PowerChain Management™ solution from Eaton:** Operates with Power Xpert® Architecture to enable seamless monitoring and management of the UPS and the entire power system, including all upstream and downstream switchgear

Key applications

- Large data centers
- Server farms
- Telecommunication installations
- Internet service providers
- Transportation systems
- Security operations
- Broadcasting and entertainment
- Process control equipment
- Financial systems
- Credit card operations
- Medical / healthcare
- Industrial systems

Best total reliability

When it comes to reliability, the Powerware 9395 leaves competitive UPSs in the dust. Providing high availability for your critical systems at all times, the Powerware 9395 was designed with numerous technological advancements that create an unprecedented level of reliability.

and within five percent for nonlinear loads—making the Powerware 9395 ideal for supporting equipment that is sensitive to a distorted voltage input as a result of harmonic loads. In the event of a utility power failure, there is no delay transferring to backup power.

Double-conversion design offers the highest protection possible

Unlike some other commercially available UPS technologies, the double-conversion design completely isolates output power from all input power anomalies and delivers 100-percent conditioned, perfect sine-wave output—regulating both voltage and frequency. Even when presented with the most severe power problems, power output remains stable. Output voltage THD is held within two percent of nominal specification for linear loads,

Inherent redundancy option

Surveys focused on efficiency in data centers reveal that UPSs are often under-loaded— frequently at less than 50 percent. To capitalize on this trend and create even greater reliability, you have the option to configure the Powerware 9395 with inherent redundancy. With this redundant configuration, the Powerware 9395 becomes inherently redundant when the load is at 50% or below of the UPS capacity. Traditional UPS manufacturers cannot deliver this additional reliability without adding a more costly second UPS module.

Inherent redundancy option:
When at or below 50% capacity,
the Powerware 9395's UPMs
automatically share the load



Powerware Hot Sync® technology: The culmination of power reliability

In configurations with more than one uninterruptible power module (UPM), the Powerware 9395 leverages the automatic load sharing capabilities of Eaton’s patented Powerware Hot Sync technology. Powerware Hot Sync enables the UPMs to share the load equally, eliminating transfer time when shifting the load from one module to the other. The load share control algorithms maintain synchronization and load balance by constantly making minute adjustments to variations in the output power requirements.

When two or more UPMs operate in parallel for capacity and redundancy, Powerware Hot Sync addresses the two primary concerns of load sharing and selective tripping. To address the two primary considerations for reliability--the degree of autonomy and the complexity of implementation--Powerware Hot Sync technology combines digital signal processing and an advanced control algorithm to provide automatic load sharing and selective tripping in a parallel system, as well as complete autonomy of the modules and a skillfully simple implementation. Optimum reliability and flexibility are achieved with the following design features in a Powerware Hot Sync paralleled system:

- Unlike other paralleling techniques, there is no system-level single point of failure
- Powerware Hot Sync systems are capable of paralleling for both redundancy and capacity
- By using a peer configuration, as opposed to a “master-slave” configuration, Powerware Hot Sync ensures that each module is operating independently
- No added circuitry or components are required to be “switched in” to operate in parallel
- With thousands of successful systems installed around the world, Powerware Hot Sync is a proven technology

Powerware Sync Control technology

Powerware Sync Control ensures that the output of two (or more) separate UPSs (single module or parallel systems) remain in phase with one another so static transfer switches connected between the separate distribution paths may change state seamlessly when necessary.

Powerware Static Auto Tie

The Powerware Static Auto Tie (SAT) system enhances reliability even further so full load transfers can be made autonomously. The Powerware SAT system adds a wrap-around static switch to the tie breaker in the Powerware Hot-Tie® system, then adds intelligent controls so a power protection system made up of two or more separate UPS systems can **automatically transfer entire** loads in the event of traumatic, catastrophic failure of one system--a rare but costly circumstance.

In the Static Auto Tie configuration displayed in the diagram at right, there is a “hot-tie” circuit between the outputs of the two UPS modules that automatically transfers the loads from one to the other as necessary. This less complex, dual-path architecture streamlines the distribution system to eliminate series switching and reduce the potential downtime of single power cord loads by up to 50 percent. As a result, the Static Auto Tie architecture offers a number of benefits, including:

- Reduced capital expenses
- Eliminates need for traditional downstream static transfer switches
- Reduced installation costs
- Increased system reliability
- Increased system efficiency
- Decreased maintenance requirements
- Reduced raised floor space requirements

Fully Deployed Static Auto Tie Configuration

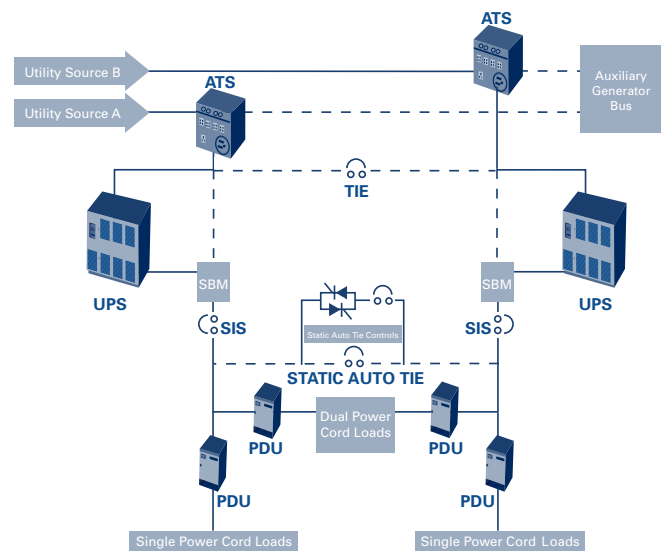

Batteries: The heart of every UPS

When a utility power outage causes a UPS to switch to battery power, it is imperative that those batteries are healthy, charged and up to the task. Improper battery management is the number one cause of downtime. Many UPS batteries on the market today are constantly trickle-charged—a process that eventually degrades the battery's internal chemical composition, reducing potential battery service life by as much as 50 percent. To address this concern, we have incorporated Eaton's ABM® technology, which uses a sensing circuitry and an innovative three-stage charging technique to significantly extend battery service life and optimize recharge time. In addition, optional temperature-compensated charging monitors temperatures and changes, and adjusts the rate of charge to prolong battery life.

Monitor batteries for optimum readiness

Advances in firmware and digital technology enable the Powerware 9395 to offer sophisticated battery monitoring and management features that you might expect to find only on expensive add-on systems, including:

- Battery runtime remaining monitor uses system loading plus internal sensing points for voltage and current data to calculate runtime remaining
- Battery circuit test performs a periodic pulse test of the battery string to ensure that there are no open circuits that would jeopardize battery performance and system availability

In addition to these integrated monitoring features, we offer one year of secure, remote monitoring to provide 24x7 real-time monitoring of more than 100 UPS and battery alarms. This real-time information is critical in helping you make management decisions, from scheduling preventive maintenance to determining the best way to shed loads during an outage.

By ensuring optimal battery health and availability, battery monitoring features raise the reliability of the Powerware 9395 beyond any other UPS in its class.

Service and support enhance performance

Eaton recognizes that superior power reliability requires flawless execution from its services team. Every Powerware 9395 includes an on-site startup from a factory-trained field technician to insure proper installation, operation, and customer training. In addition, we include a full year of on-site 24x7 parts and labor warranty and service protection plan coverage at no extra charge. Finally, our experts will remotely diagnose, trend, and proactively spot problems and expedite field technicians with appropriate parts when required during the first year with our advanced eNotify Remote Monitoring Service. Included at no extra charge with every Powerware 9395:

- 24x7x365 startup service and customer training
- One-year limited factory warranty¹
- Service protection plan 24x7 coverage, eight-hour response (upgrade to four- or two-hour where available), parts and labor, unlimited on-site emergency response support
- eNotify Remote Monitoring Service: 24x7 critical alarm notification and monthly reports on UPS and battery health
- 24x7 technical support access

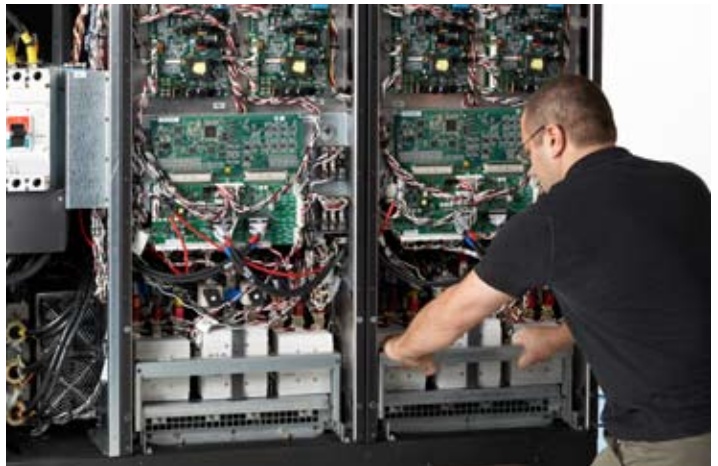

In addition to the warranty and first year of on-site coverage, Eaton offers a wide variety of support agreements for continued preventive and emergency response maintenance. PowerTrust Service Plans include:

- UPS and battery scheduled preventive maintenance
- Parts and labor coverage for electronics and/or batteries
- Factory-trained technicians with genuine Powerware parts and diagnostic tools
- eNotify Remote Monitoring Service
- Available coverage: 24x7, eight/four/two-hour response, or 8x5 next business day response
- 24x7 technical support access

eNotify Remote Monitoring Service

All PowerTrust Service Plans include Eaton's eNotify Remote Monitoring Service, enabling Eaton service technicians to remotely monitor your UPS and batteries using one-way emails. With technical experts available to respond immediately and resolve many issues remotely, eNotify features 24x7 real-time monitoring of 100+ UPS and battery alarms.

The eNotify Service provides you with monthly reports detailing the ongoing health of your Powerware 9395 UPS. The Customer Monitoring Report delivers information on your unit's voltages, loads, and external factors such as temperature and humidity. Additionally, the report provides information about the attached batteries and system availability. All of these factors contribute to the Relative Health Index (RHI) score that allows you to compare your unit's health to Eaton's optimum Powerware UPS operating levels.

Proactive monitoring is also included. Upon receipt of both status and event e-mails, anomalies are checked for incoming parametric or event data logs. If an anomaly is detected, Eaton analysts further study the data for possible impending failures and take appropriate action. The following critical alarms are provided by eNotify:

- UPS output power will turn off after the configured delay period
- Low battery alarm present
- UPS hardware fault detected
- UPS battery completely discharged
- UPS inverter fault detected
- UPS internally bypassed
- UPS output has been turned off
- UPS shutdown imminent alarm condition exists
- The failure of one or more fuses has been detected
- A relay, contactor, or breaker has failed

The eNotify Remote Monitoring Service provides confidence that Eaton is continually watching your Powerware 9395 and will combine its technical resources and field technicians as needed to quickly respond to critical alarms.

The innovative design of the Powerware 9395 delivers the industry's best performance combination of high efficiency, low input current distortion and high power factor.



Sent via email to as many as six site contacts, the eNotify monthly Customer Monitoring Report provides a summary of the top 10 performance and environmental parameters, battery events, availability percentage, and comparative status against recommended specification.

Unmatched green power performance

The innovative design of the Powerware 9395 delivers the industry's best performance combination of high efficiency, low input current distortion and high power factor. The Powerware 9395 operates at an industry-leading 95 percent efficiency, reducing utility costs and extending battery runtimes. Higher system efficiency also results in cooler operating conditions, which reduces facility air conditioning cost, extends the life of UPS components, and increases overall reliability, availability, and performance. A new input circuit design within the Powerware 9395 keeps input current THD low and input power factor near unity without compromising overall efficiency. As a result, the UPS allows maximum transfer of power between the power source and the protected load and is exceptionally compatible with multiple power sources, especially auxiliary generators. On the output side, the ultra high-speed switching pulse width modulation (PWM) inverter enables the Powerware 9395 to provide its full rated power capability to the load whether the load power factor is 0.9 lagging, unity, or 0.9 leading.

Measuring power performance: Efficiency, power factor, and THD

Power performance, which is measured by system efficiency, output power factor, and THD, is the foundation of the Powerware 9395. It is the UPS's robust combination of these three elements that make it stand out as the premier UPS in its class. The table below demonstrates how the Powerware 9395 compares to competitive UPS models. Most manufacturers must use input filters, which lower their efficiency rating even further than what is listed below. The Powerware 9395, on the other hand, does not require input filters to obtain less than three percent THD. Considering the value of just a two percent difference in efficiency in a 550 kVA application, the Powerware 9395 will provide more than \$20,000 in electrical and cooling savings per year!

POWERWARE 9395 POWER PERFORMANCE VS. THE COMPETITION

Model	kVA Rating	Full Load Efficiency	Output Power Factor	Input THD at Full Load
Powerware 9395	550	95.0%	0.9	<3%
Competitor A	500	94.0%	0.9	7%
Competitor B	500	93.0%	0.9	7%

The importance of system efficiency

To demonstrate the importance of total system efficiency in relation to load level, the graph below shows how efficiency generally dips as load level decreases. In general, manufacturers list an optimal efficiency rating at full load. In reality, however, most three-phase UPSs operate well below full load. As a result, it is extremely important to evaluate the efficiency of a UPS at lighter loads as this graph depicts.

Efficiency vs. Load

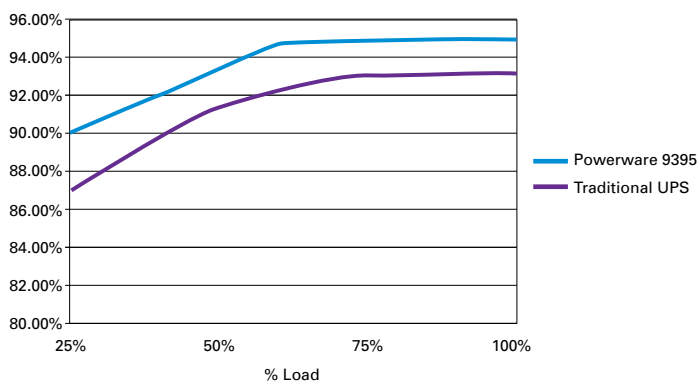

Easy load testing

The Powerware 9395 tests its entire power train under full load stress without the requirement of an external load. With no load connected, the Powerware 9395 is able to test all of its power handling components, including the rectifier, inverter, contactors, fuses, power busses, cabling, batteries, bypass (static switch), magnetics, and filter capacitors. The net result of this innovative load test is that there are no load banks to rent, no temporary load connections to make, and no wasted energy. Furthermore, the Powerware 9395 has the ability to test the upstream bypass input breaker (BIB), the rectifier input breaker (RIB), and all of the electrical cables between them. This load test feature can take the place of some traditional load bank tests to save you time and money during startup and commissioning.

Eaton field technicians are trained to use this load testing capability during a startup service to ensure optimum calibration and maximum efficiency. As a result, they can produce a report that verifies these tests and overall performance of the UPS. All preventive maintenance visits included with PowerTrust Service Plans for the Powerware 9395 include this unique load testing feature to ensure that the UPS is operating optimally. It also validates the performance of an installed UPS and can simulate various operations and power transfers.

Scalable, redundant architecture meets current and future requirements

The Powerware 9395 combines the reliability and redundancy of a multi-module UPS into an integrated, pre-wired solution. With a unique, flexible design that provides scalability, the UPS can adapt to future changes in load demands and new requirements for higher reliability without requiring the purchase of an additional UPS. For example, the Powerware 9395 UPS enables you to add a 275 kVA UPM in the field for N+1 redundancy or capacity.

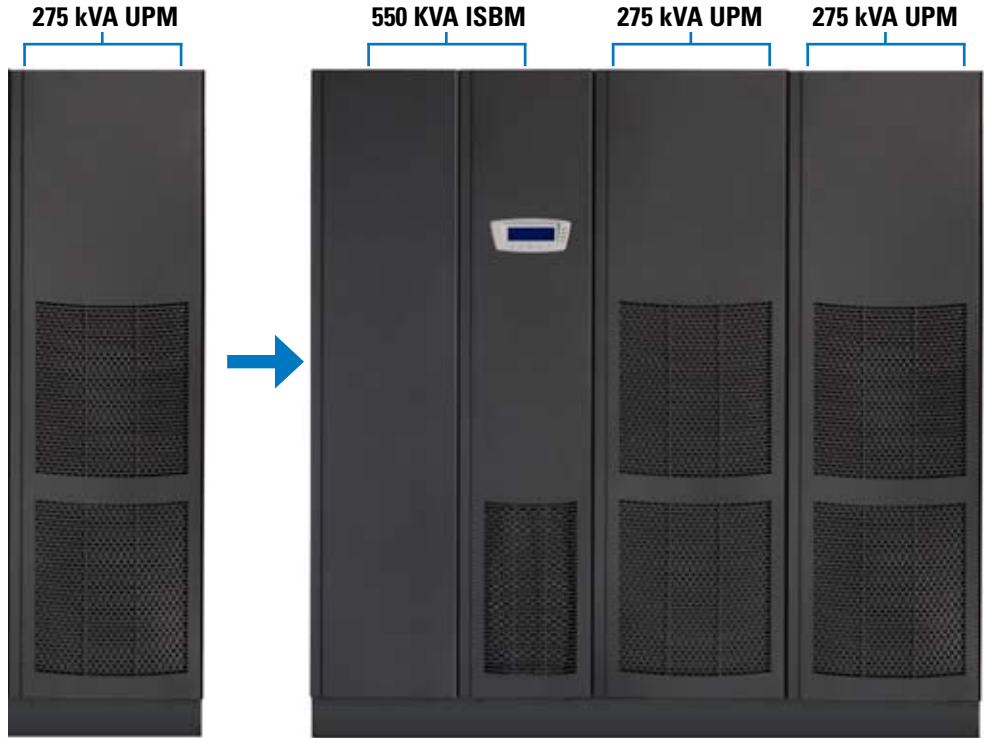

On-site Upgrade

Concurrent maintenance: Higher availability

With Powerware 9395 redundant models, Eaton field technicians can completely isolate and service a redundant module while the other module carries the load--without going to bypass for service. The Powerware 9395 also features a completely front-accessible design and can be installed against walls or back to back in multi-module configuration. This service-friendly design enhances maximum uptime and availability.

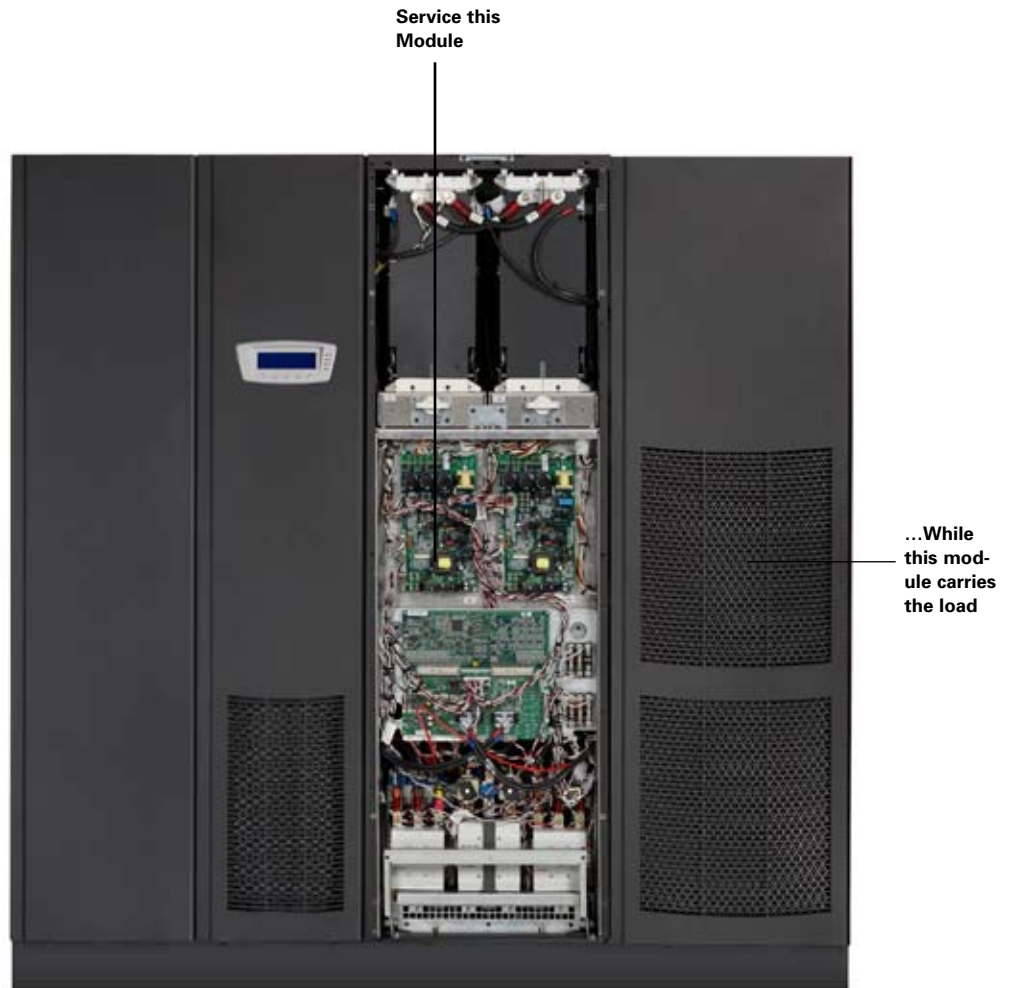

Ease of installation

Traditional multi-module installations involve three times the connections for inter-unit power and communications cabling. In contrast, the Powerware 9395 is a completely integrated large system that eliminates the need to install internal conduits to power module frames. Since everything is pre-wired, cabling costs and installation time are significantly reduced. The illustration below depicts a comparison with a traditional system:

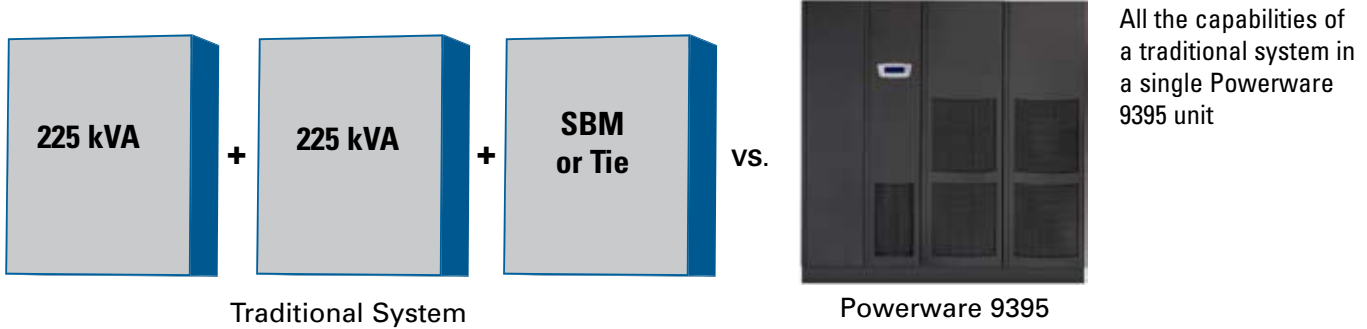

Minimized cabling requirements and expense

In an integrated system such as the Powerware 9395, multi-module systems arrive pre-wired with no need to perform costly and time-consuming inter-unit cabling for power and communications between modules and the system bypass unit. Considering the increasing cost for raw materials such as copper, this savings can be significant. Cabling enters the Powerware 9395 UPS from either the top or bottom of the cabinet to provide easier and more flexible installation.

Greatly reduced footprint

The Powerware 9395 UPS offers the smallest footprint and lowest weight of any UPS in its class—50 to 60 percent less than competitive units. In fact, the Powerware 9395 fits a redundant design into the same footprint as a traditional, non-redundant UPS. The Powerware 9395's smaller footprint not only reduces your total cost of ownership, but also provides a UPS that is approximately half the weight of legacy and competitive systems. As a result, freight costs are much lower and the smaller size and weight of the UPS make it much easier to handle. In fact, the Powerware 9395 fits easily through all doors and can be transported on freight elevators. Unlike some larger and heavier systems, there is no need to dismantle it to fit it on elevators or through doorways, which can cause significant delays and increase costs.

Reliable Eaton components

The Powerware 9395 leverages reliable and proven electrical components manufactured by Eaton such as Cutler-Hammer circuit breakers and contactors.



The Powerware 9395 features Cutler-Hammer LG-series input circuit breakers rated at 65 and 100 kAIC

Eaton's total PowerChain Management solution

Eaton views your power system as a strategic asset—an approach we call PowerChain Management. Eaton's PowerChain Management solutions can help transform complicated power systems into a single, integrated system easily visible and manageable as a strategic business asset, providing a significant competitive advantage.

If your company is like most, its power system was built over time. As the organization's needs changed, additional equipment was likely piece-mealed into the system, with a circuit breaker added here and a transformer replaced there. The result can be a power system that is a complicated mixture of old and new equipment from several different manufacturers. Because there is no common means of communicating across this varied equipment, gathering data across the enterprise can be quite challenging.

Enhance your business visibility to see the entire picture

The complexity of gathering data among various devices makes it difficult to get a clear picture of what's happening inside your power system, which decreases your ability to manage your power system effectively. Consequently, business results suffer, because your enterprise depends on its power system.

Eaton's Power Xpert® Architecture, the backbone of our PowerChain Management solutions, enables you to monitor much more than your Powerware 9395 UPS; it transforms your power system into an integrated, agile system that delivers real competitive advantages. With the software and hardware components of Power Xpert Architecture, you can monitor, control, and manage your complete power system effectively and efficiently, including PDUs, batteries and other critical equipment. Using a simple, Web-based interface, the varied elements of your power system are integrated into a single view, with the ability to easily monitor the availability and reliability of electrical power, lower energy costs, extend equipment life, and more.

Optimize your power system

PowerChain Management can also help you manage your power system for peak performance by integrating and optimizing your power assets and ensuring that they align with your business goals.

Once your power system is linked to an Ethernet network via the Power Xpert Architecture, you can connect to and share information with a variety of applications, such as the building management system monitoring your HVAC equipment, or your enterprise accounting system. Power Xpert Architecture's open standards and scalable approach make it easy for your power system to grow and adapt to a rapidly changing environment.

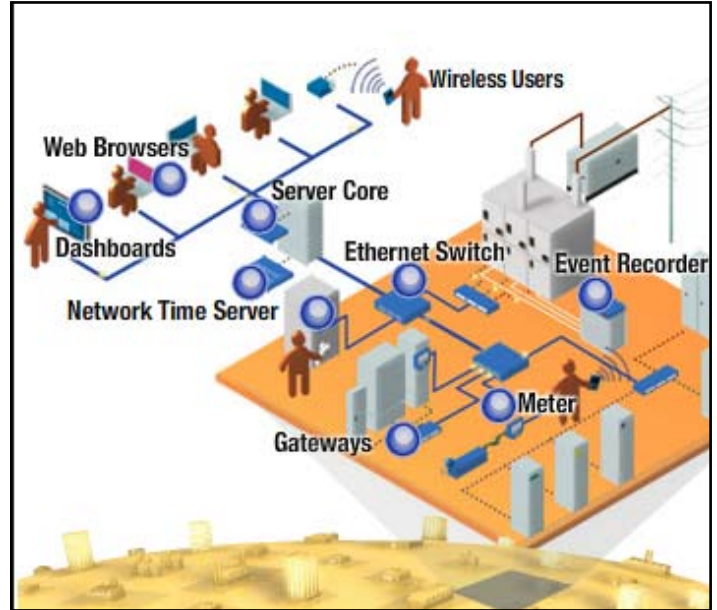

Eaton delivers a new level of confidence

The culmination of 40 years of R&D excellence, the new Powerware 9395 UPS delivers the utmost in confidence—confidence that your organization's critical systems are protected by the most reliable, efficient, and full-featured protection solution available. Eaton will be there with you long term, with premium warranty coverage and expert technical support. **To find out more about the Powerware 9395 UPS, visit our Web site at www.powerware.com/9395, or contact us at 1.800.356.5794.**



The ConnectUPS-X Web/SNMP Card allows you to connect your Powerware 9395 directly to the Ethernet network and the Internet. This unique solution allows you to conveniently monitor and manage your UPS with a standard Web browser. The ConnectUPS Card is also used to take advantage of Eaton's 24x7 eNotify Remote Monitoring Service.

Core components

The Powerware 9395 is composed of two core components:



A closer look inside the Powerware 9395

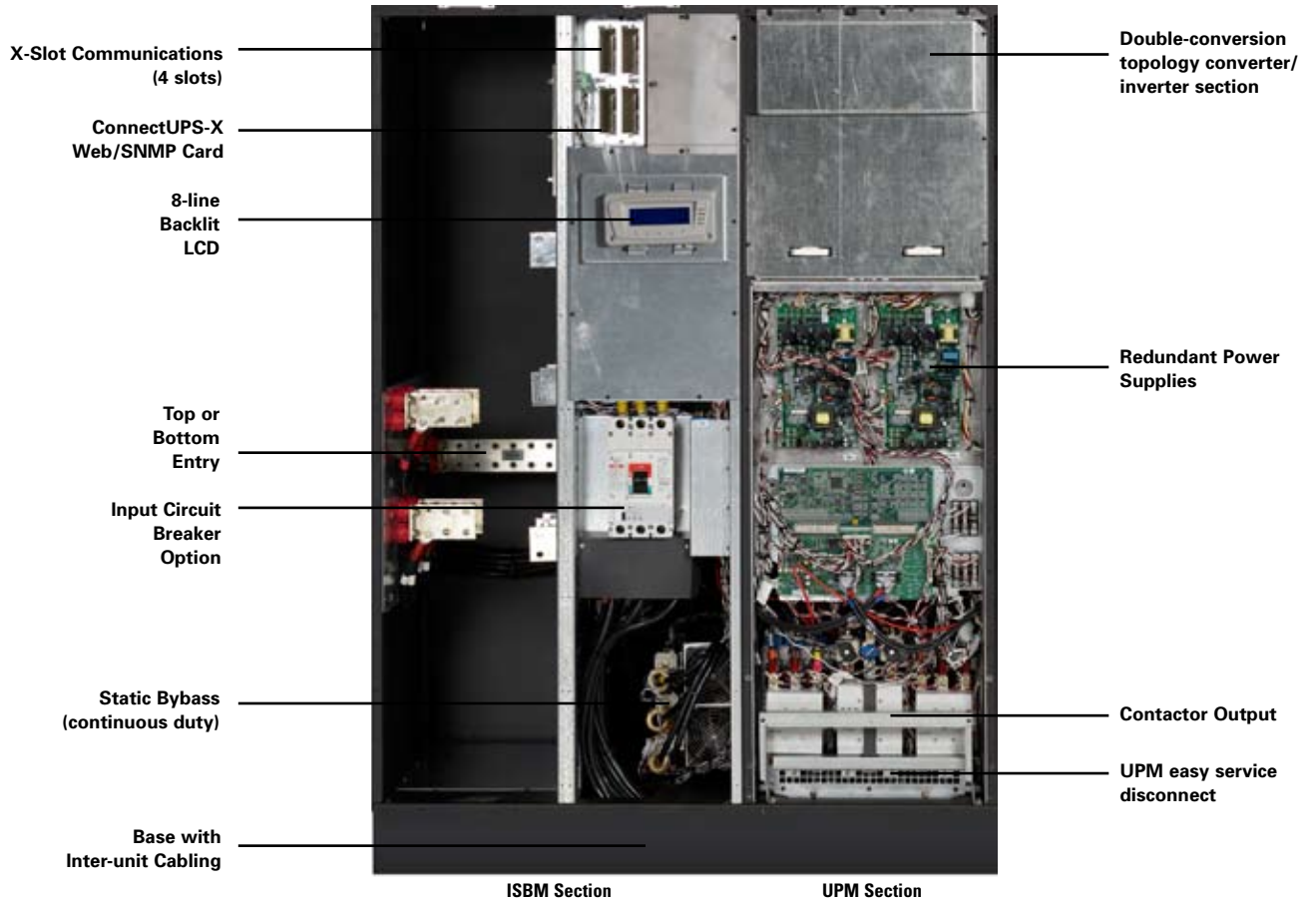

Technical Specifications²

UPS Rating (0.9 power factor)

kVA	225	275	450	500	550
kW	202	250	405	450	500

General Characteristics

Efficiency	95%
Parallel Capability	Up to 3 modules, 550 kVA maximum
Audible Noise	< 65dBA @ 1 meter
Altitude (max)	2000m at 40°C (104°F)
N+1 Redundancy Capable	Yes
Field Upgradeable	Yes, 275 kVA increments
System Bypass Module	Included

Input Characteristics

Voltage	480V standard; 208V and 600V with isolation transformer option
Voltage Range	+10% / -15%
Frequency Range	55-65 Hz
Power Factor	0.99 (minimum)
Input Current Distortion	<3% (no input filter required)
Soft Start Capability	Yes
Internal Backfeed Protection	Yes

Output Characteristics

Voltage	480V standard; 208V and 600V with isolation transformer option
Regulation	±1%
Inverter	PWM with IGBT switching
Voltage THD	<2% (100% linear load); <5% (non-linear load)
Load Power Factor Range	Up to a .9 power factor leading without derating

Battery

Battery Types	VRLA, AGM, Gel, Wet
Battery Voltage	480V
Temperature Compensation	Optional
Charging Method	ABM technology

Dimensions and Weights

225 kVA, 275 kVA	52.4" w x 32.7" d x 73.6" h	1786 lb
225 kVA redundant, 275 kVA redundant	73.7" w x 32.7" d x 73.6" h	2875 lb
450, 500, 550 kVA	73.7" w x 32.7" d x 73.6" h	2977 lb
450, 550 kVA redundant	95.4" w x 32.7" d x 73.6" h	4153 lb
Field upgrade module, 225 or 275 kVA	21.3" w x 32.7" d x 73.6" h	1176 lb

General Characteristics

Control Panel (LCD)	8 lines x 40 characters
Battery Startup	Standard
Frequency Conversion	Standard
Multi-language	Standard
Building Alarm Inputs	6 (galvanic isolated)

Options

External Maintenance Bypass	
Powerware PDU, RPP, and STS	
External Isolation Transformer	
External Output Transformer	
Maintenance Bypass Module	
DC Disconnects	
65 or 100 kAIC Input Breakers	

Certifications

Safety	UL1778, cUL
EMC	IEC 62040-2, EN50091 Class A
Surge	ANSI C62, 41, Cat. A&B

eNotify Remote Monitoring

24x7 remote monitoring of UPS and battery alarms, daily heartbeat check and monthly report. Includes ConnectUPS-X Web/SNMP Card and Environmental Monitoring Probe.

Communications

Software Compatibility: Power Xpert
 Communications Cards: Four communication bays standard. The following connectivity options can be installed at any time:

- ConnectUPS-X Web/SNMP Card (included)
- ModBus RTU Card
- AS/400 Relay Card
- Industrial Relay Card
- Powerware HotSync CAN Bridge Card
- Environmental Monitoring Probe (included)
- Modem Card

Remote Inputs/Outputs: Six building alarm inputs and one summary alarm contact (5A @ 120V) standard

Remote Monitor Panel: Eight backlit status indicator lamps plus an audible horn

2. Due to continuing improvements, specifications are subject to change without notice.



UNITED STATES
 8609 Six Forks Road
 Raleigh, NC 27615 U.S.A.
 Toll Free: 1.800.356.5794
 or 919.872.3020

www.powerware.com/9395

CANADA
 Ontario: 416.798.0112
 Toll free: 1.800.461.9166

LATIN AMERICA
 Argentina: 54.11.4343.6323
 Brazil: 55.11.3616.8500
 México: 52.55.5488.5252

EUROPE/MIDDLE EAST/AFRICA
 Denmark: 45.3686.7910
 Finland: 358.94.52.661
 France: 33.1.6012.7400
 Germany: 49.7841.666.0
 Italy: 39.02.66.04.05.40
 Norway: 47.23.03.65.50
 Sweden: 46.8.598.940.00
 United Kingdom: 44.1753.608.700

ASIA PACIFIC
 Australia/NZ: 61.2.9693.9366
 China: 86.21.6361.5599
 HK/Korea/Taiwan: 852.2745.6682
 India: 91.11.2649.9414 to 18
 Singapore/SEA: 65.6825.1668

Eaton, Powerware, PowerChain Management, Power Xpert, Powerware Hot Sync, Hot-Tie, ABM, and PowerChain are trade names, trademarks, and/or service marks of Eaton Corporation and its subsidiaries or affiliates.

© 2007 Eaton Corporation
 All Rights Reserved
 Printed in USA
 9395FXA
 August 2007

